

User Manual

MagniLink iTAB

**LVI Low Vision International**

Verkstadsgatan 5
SE-352 46 Växjö

Tel: +46 470-727700

info@lvi.se
www.lvi.se

Table of contents

1 About LVI.....	1
2 Introduction to MagniLink iTAB.....	2
3 Information.....	4
3.1 Reuse, installation and maintenance.....	4
3.2 Cleaning.....	4
3.3 Safety information.....	4
4 Unpacking.....	6
4.1 Packaging.....	6
5 Hardware.....	7
5.1 Stand.....	7
5.2 Tablet computer.....	8
5.3 Distance camera.....	8
5.4 Connection.....	8
6 MagniLink Viewer.....	10
6.1 Minimum system requirements.....	10
6.2 Recommended system requirements.....	10
6.3 Installation of software.....	10
6.4 Activate driver.....	11
6.5 Using the software.....	11
6.5.1 Functions via menus.....	11
6.5.2 Functions via gestures.....	22
6.5.3 Functions via the keyboard.....	25
6.5.4 Information and settings window.....	29
7 Ergonomics.....	35
8 Technical information.....	36
9 Declaration of Conformity.....	38

1 About LVI

LVI Low Vision International AB was founded in 1978 and is one of the world's leading manufacturers of equipment for persons with visual impairments. Development of new products takes place in close cooperation with users and professional staff within the low vision rehabilitation industry. LVI is quality-certified in accordance with ISO 9001 and environmentally-certified in accordance with ISO 14001.

The information in this manual has been carefully checked and is believed to be accurate. However, LVI assumes no responsibility for any inaccuracies that may be contained in this manual. In no event will LVI be liable for direct, indirect, special, exemplary, incidental, or consequential damages resulting from any defect or omission in this manual. In the interest of continued product development, LVI reserves the right to make improvements in this manual and the products it describes at any time, without notice or obligation.

2 Introduction to MagniLink iTAB

Thank you for choosing this system. Our aim is for you to be satisfied with your choice of supplier and vision aid.

The MagniLink iTAB system consists of a stand and distance camera, developed for the Apple iPad. The system's features include autofocus, several artificial colours, and adjustable magnification. It allows for text to be processed via OCR, which can then be read aloud by a speech synthesiser.



The following models are available. All models come with a stand. iPad not included and must be purchased separately.

Model	Camera	For iPad models
ML-iTAB-SC-11	Yes	iPad Pro 11"
ML-iTAB-SC-12.9	Yes	iPad Pro 12.9"
ML-iTAB-SC-13PRO	Yes	lpad Pro 13"
ML-iTAB-S-11	No	lpad Pro 11"
ML-iTAB-S-12.9	No	iPad Pro 12.9"
ML-iTAB-S-13PRO	No	lpad Pro 13"



The systems complies with all CE certification requirements for medical devices in accordance with EU regulation 2017/745.



Medical Device

The MD symbol indicates that the product is a medical device in accordance with Regulation (EU) 2017/745 (MDR).



The product complies with all applicable requirements of the FCC rules.

3 Information

3.1 Reuse, installation and maintenance

The device may only be technically overhauled and prepared by an authorized company. Re-use may only be carried out after appropriate inspection and cleaning / disinfection.

3.2 Cleaning

Before equipment cleaning and maintenance note:

- Disconnect the device from the power supply before cleaning.
- Use a slightly damp (not wet) cloth and a cleaning / disinfectant agent intended for monitors and computers.
- Do not allow any liquids to enter the device.

3.3 Safety information

- Never operate the product if it has been exposed to water or other liquids. Damaged or wet product can cause electric shocks or fire.
- The product contains a neodymium magnet. This is a potential risk for a user with a pacemaker. If the magnet gets too close, its magnetic field can interfere with the operation of the pacemaker.
- If the product is moved from the cold into a warm room, condensation (moisture) can form inside the unit or on the camera lens. To prevent problems with condensation, the apparatus should be installed in the room at least 30 minutes prior to usage.
- If the system requires cleaning, pull out all cables and use a slightly damp (not wet) cloth. Use only water or a cleaning agent that is intended for monitors and computers.
- When the system is to be moved, remove the distance camera (where applicable), collapse the system and lift it via the handle.
- Be careful not to catch your fingers when collapsing the system.
- Do not rely 100 per cent on the results of an OCR conversion; the OCR engine can misinterpret the text. This is particularly important to bear in mind when processing sensitive information such as a medical prescription.
- Serious incidents that have occurred in connection with the product shall be reported to the manufacturer and to the competent authority in the Member State where the user is established.

If in doubt, contact your supplier.

**Warning**

The product is supplied packed in a plastic bag. To avoid risk of suffocation, keep the bag out of the reach of children and infants.

4 Unpacking

The system is supplied in a box with the following contents:

- Stand
- Distance camera
- Polishing cloth
- Charger USB-C 65W
- Carrying case
- User Guide

First, check that the box has no external damage. In the event of any damage, contact the transport company and file a claim.

Open the box and remove the MagniLink TAB and remove the packaging parts.

4.1 Packaging

The packaging consists of the following packaging material (LVI recommends that the packaging be kept in case you have to return the system or you need to move it):

- Packing material (XPE)
- Box (corrugated cardboard)
- Polyethylene (LDPE4)

For sorting and collection of packaging material, please call the packaging collection customer service department for information on the rules that apply in your municipality.

5 Hardware

5.1 Stand



The stand consists of an arm with a holder for an iPad. The stand's arm also functions as a handle when collapsing and moving the system. In the stand there is an attachment for a distance camera. An integrated hub is also built into the stand. This hub makes it possible to connect the distance camera and charge the iPad at the same time.

5.2 Tablet computer

5.3 Distance camera



The distance camera connects to the stand with a USB cable. The lens of the camera can be folded down if you wish to look at an object from a distance.

5.4 Connection

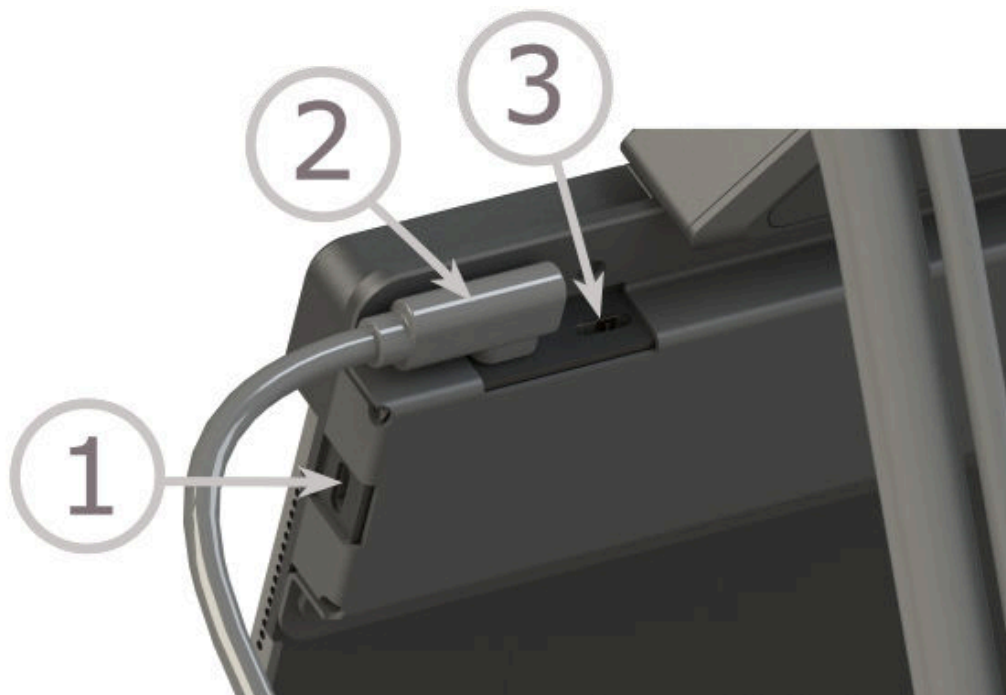

There are three USB-C ports available.

1. A USB flash drive can be connected here.
2. Connect the camera here.
3. Connect this port to a charger. To charge during use, the charger should be at least 20W.



Note

Since the camera draws power when plugged in, it is recommended to unplug the cord when not in use.



Note

When the charger is in use, plug in all other cables before the charger. Otherwise, you may not get a working camera image.

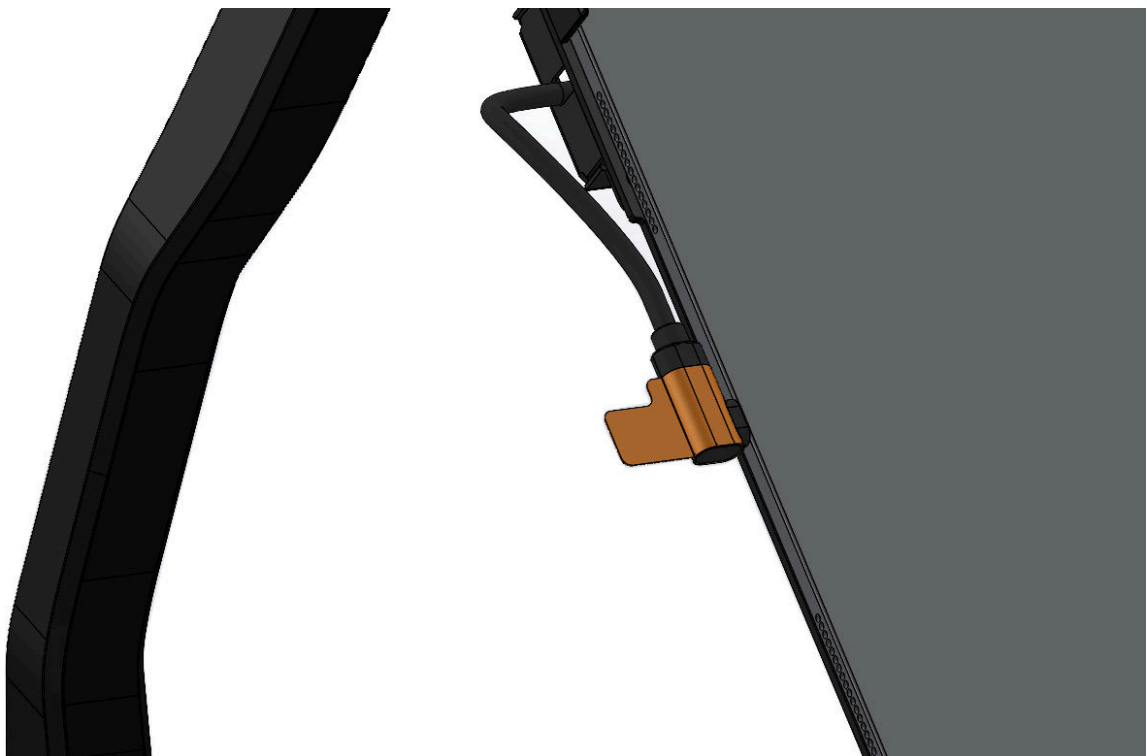

Note

Since the hub draws power when plugged in, it is recommended to unplug the cord when the device is not in use.

6 MagniLink Viewer

MagniLink Viewer is a software developed for iPad. The software can display images from a MagniLink camera system and the built-in cameras. The software can control camera properties such as magnification level, artificial colours and brightness.

6.1 Minimum system requirements

- iPad with a USB-C connector and M2-chip or newer.
- iPadOS 17.0 or later.

6.2 Recommended system requirements

- iPad Pro 13" with M2-chip or newer.
- iPadOS 18.0 or newer.

LVI has tested the software on several iPads with above specification without any problems, but there is no guarantee that the system will function on all iPads that comply with the specifications. LVI recommends testing the software on the iPad where the system is to be used, in order to ensure compatibility. Please look up the feature to reduce framerate and picture quality under camera settings, this to reduce any delay.

6.3 Installation of software

Enter **App Store** and click **Search** in the lower right-hand corner.

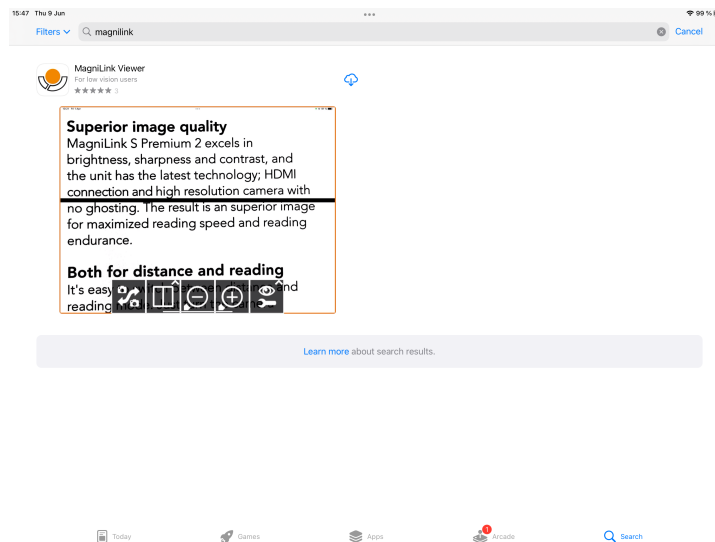

Click the download icon to install the software.

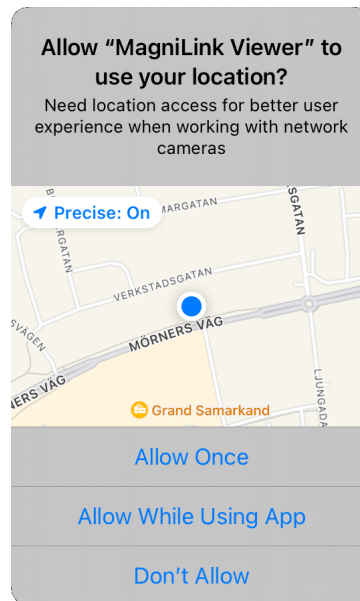

Click **Allow while using the app**.

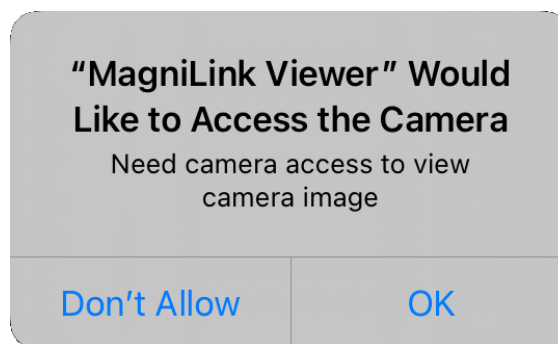

Click **OK**.

6.4 Activate driver

To control the camera functions, the driver MagniLink Driver 7 must be activated. If the driver is not active, a message is displayed. By pressing "Settings" you get to the iPad's settings where you can activate the driver.

6.5 Using the software

6.5.1 Functions via menus

6.5.1.1 Camera view

The following menu is displayed when the application is started.





Switch views

Switches to the OCR view. Press and hold to switch to the Notepad view.



Switch camera

Switch between the remote camera and the built-in cameras.



Split Mode

Opens a submenu where you can set the split mode.



Lock autofocus

Locks the autofocus mode. This can be used when you wish to write by hand. In this way, autofocus is not affected by the pen or your hand. Press the button a second time to reactivate autofocus.



Focus up

Reduce focus distance. When this function is used, autofocus is turned off.



Focus down

Increase focus distance. When this function is used, autofocus is turned off.



Lamp

Change lamp brightness. There are five modes: Off, 25, 50, 75 and 100 percent.



Switch between rear and front camera

This feature is available on iPhone and older iPads where you cannot view the two built-in cameras at the same time.



Change Image Source

Used to swap image sources (if there are more than two sources).



Change split mode

Change between vertical and horizontal split mode.



Move split left

Moves the split mode to the left.



Move split right

Moves the split mode to the right.



Decrease magnification



Increase magnification



OCR

Start OCR. When the OCR process is complete, the application switches to the OCR view and reading begins. You cannot switch using press and hold.



AI (license required)

Takes a picture and switches to the AI view. It is then possible to ask questions about the picture. With a long press, the application switches without taking a picture.



Take picture and record video

Opens a submenu with the following buttons.



Scan QR code

Scans a QR code. If the QR code contains a link, a dialog will open where you can open the link. It is also possible to activate a license by scanning a QR code.



Freeze

Freezes the camera image. A new press releases the freeze.



Take picture

There is an audible click, and the image is saved. The image can then be opened in the “Images” app. The file name will be today’s date and the current time.



Record video

Start recording. The application will display an icon indicating that recording is in progress. Stop recording by pressing the button again. The clip can then be opened in the “Images” app. The file name will be today’s date and the current time.



Notepad

Opens the camera image in the notes tool.



Video settings

Opens a submenu with the following buttons.



Advanced zoom

Enable or disable advanced zoom. When enabled, the image can be digitally zoomed and panned.



Video stabilization

Enable or disable video stabilization.



Whole image

Switch between full image and cropped image. In full image, the image is scaled so that the entire image is displayed. In cropped image, the image is scaled so that it covers the entire screen.



Switch natural colours

Switch between natural colours and grey scale.



Switch artificial colours

Switch between artificial colours. Press and hold to switch back.

**Reduce brightness/contrast****Increase brightness/contrast****Mirror the camera image**

Press again to reverse the mirror image.

**Rotate the camera image**

Rotates the camera image clockwise. Press and hold to rotate anti-clockwise.

**Reference line/vertical bar left/up**

Adjusts the position of the reference line. Press the button to move the reference line to the left. Hold the button in to change the reference line to horizontal and move it upwards. The reference line then becomes a vertical bar, which diminishes the viewing area. To make the bar horizontal, press the button again.

**Reference line/bar right/down**

Same as the previous command but in the opposite direction.

**Settings**

Opens the Settings view.

6.5.1.2 OCR view

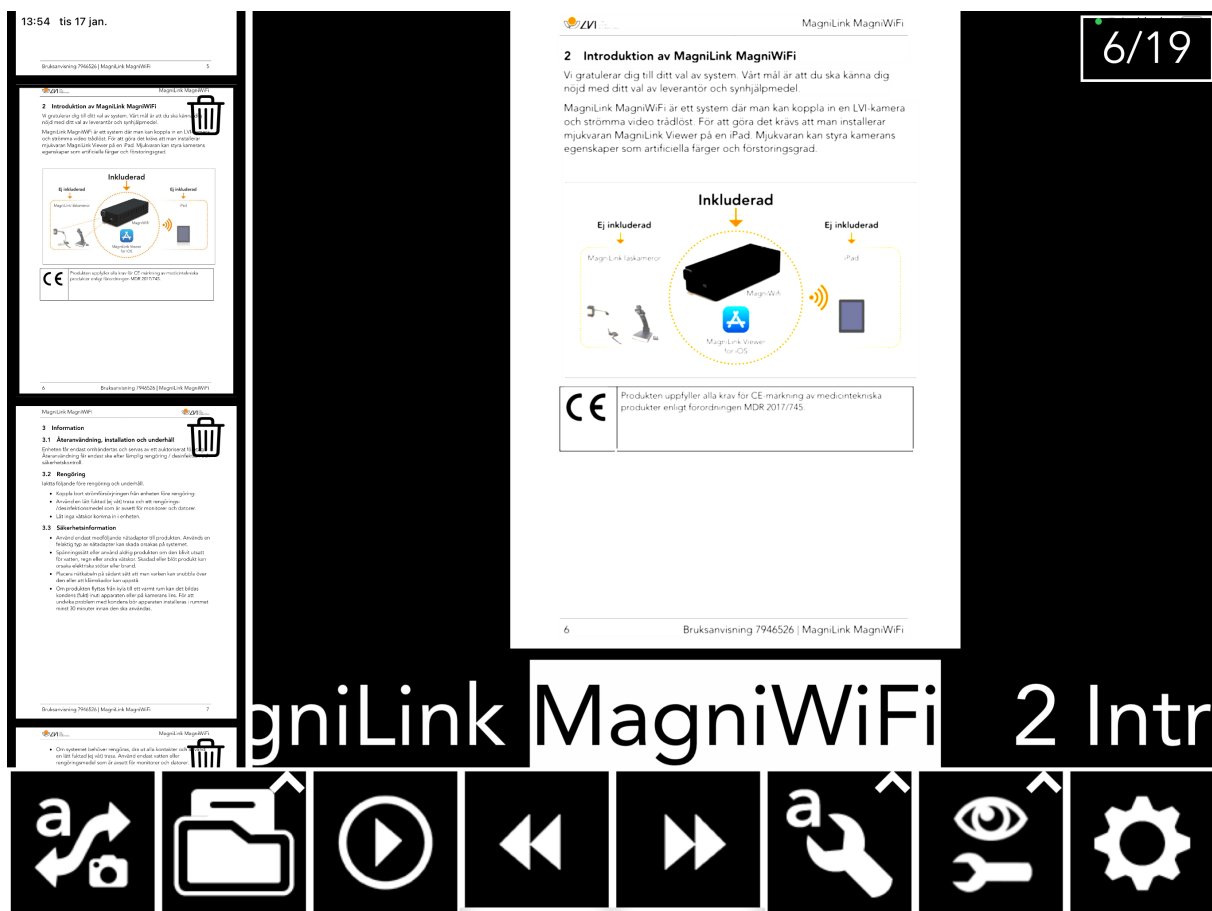

The OCR view consists of three components.

- At the bottom is a menu bar with buttons.
- To the left is a list of pages that have been OCR processed previously. By clicking on a page, you can navigate to it.
- An area showing the OCR processed page. The current page number is displayed top right.



Switch views

Switches to the camera view. Press and hold to switch to the Notepad view.



Handle documents

Opens a submenu where the following alternatives are found.



Hide sidebar

Hides the list on the left where previously OCR processed pages are displayed.



Open document

From the dialog box, select the file you wish to open. It is possible to open PDF files and saved ZIP files.



Save document

A dialog box where you can choose the file format (PDF, Zip and RTF) appears. You can then choose where you want to save the file.



Remove

Remove the current page.



Notepad

Opens OCR processed pages in the notes tool.



AI (license required)

Opens the OCR-processed text in the AI tool.



Start reading

Start reading. Press again to stop reading.



Previous

Skip backwards in the text. Depending on which reading mode is selected, you will skip back to the previous character, word, sentence or block. Press and hold to switch to the previous page.



Next

Skip forwards in the text. Depending on which reading mode is selected, you will skip forwards to the next character, word, sentence or block. Press and hold to switch to the next page.



Text settings

Opens a submenu with the following settings.



Switch reading mode

Switch to next reading mode. The modes available are: character, row, sentence and block.



Switch display mode

Switch display mode. The display modes available are “page view”, “row view”, “word view”, “image view”, “image and word” and “image and row”.



Increase font size



Reduce font size.



Image settings

Open a submenu with the following buttons.



Switch natural colours

Switch between natural colours and grey scale.



Switch artificial colours

Switch between artificial colours. Press and hold to switch back.



Increase brightness/contrast



Reduce brightness/contrast



Settings

Opens the Settings view.

6.5.1.3 Notepad view



The notes tool consists of three components.

- To the left is a list of images that have been opened previously. By clicking on an image, you can navigate to it.
- An area where you can draw, enlarge and pan through the image.
- At the bottom is a menu bar with buttons.



Switch views

Switches to the camera view. Press and hold to switch to the OCR view.



Handle documents

Opens a submenu where the following alternatives are found.



Hide sidebar

Hides the list on the left where previously opened images are displayed.



New image

Opens a new blank image that you can draw in.



Save document

A dialog box where you can choose the file format (PDF and JPEG) appears. You can then choose where you want to save the file.



Open document

From the dialog box, select the file you wish to open. It is possible to open PDF files and image files.



Remove

Remove the current page.



Pen

Draw with a pen. Press and hold to open a dialog box where you can choose the colour and size.



Highlight

Highlight with a highlighter. Press and hold to open a dialog box where you can choose the colour and size.



Text tool

Insert text. Press and hold to open a dialog box where you can choose the colour, size and font. You can move text around after inserting. Double-click the text to change it.



Delete



Enlarge and pan in the image.



Undo



Restore

Restore after pressing undo.



Rotate

Any changes you made to the image will be removed if you rotate.



Settings

Opens the Settings view.

6.5.1.4 AI view

To use the AI tool, you need an internet connection and a valid license.

With the help of the AI tool, you can, among other things, summarize long documents for faster reading, translate text between several languages and get detailed answers to questions on different topics.

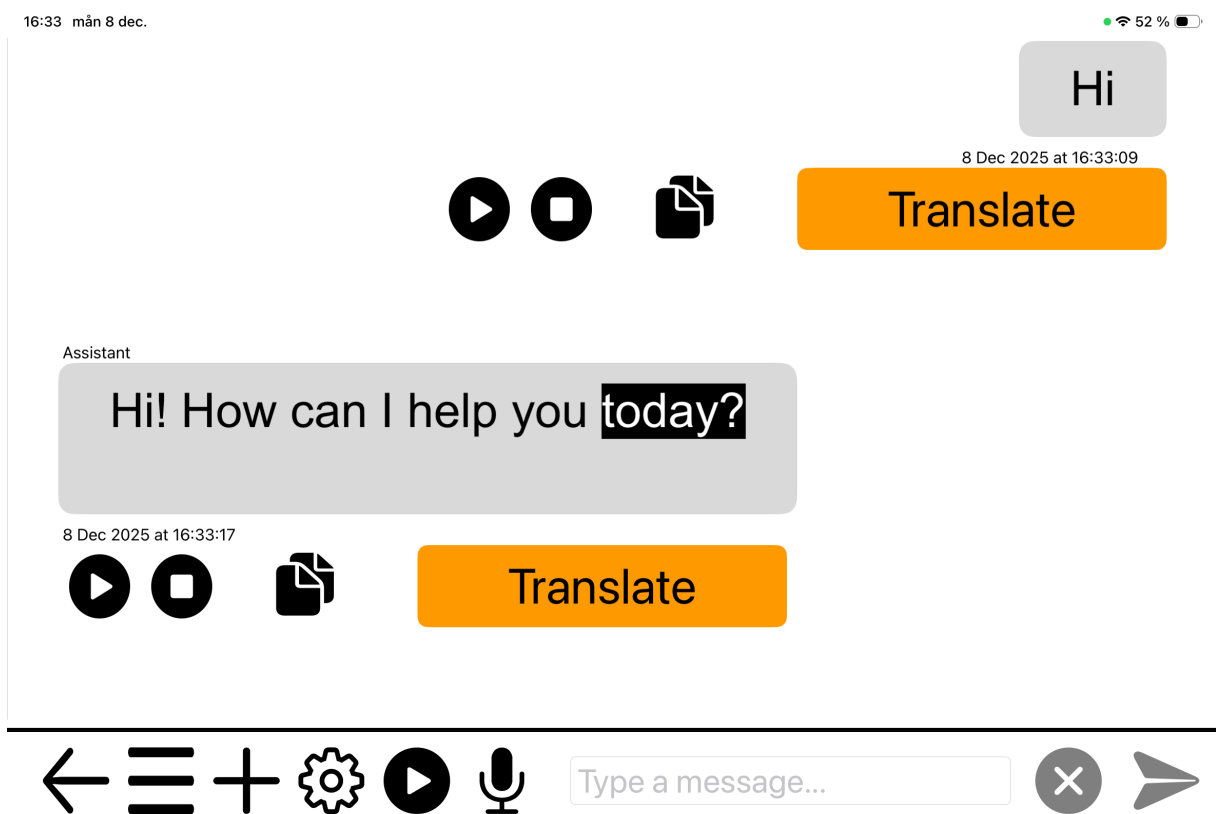

The AI tool consists of three components.

- A list of conversations. By clicking a conversation, you can make it active. The list is hidden by default and can be shown by pressing a button.
- An area where messages are displayed as chat bubbles.
- At the bottom there is a menu bar with buttons and an input field.



Back
Back to the camera view.



Menu
Display the menu containing conversations.



Create conversation
Creates a new conversation and adds it to existing ones.



Settings
Opens the settings.



Start reading
Starts reading. A new press stops the reading.



Voice input
When the button is pressed, the input starts. When you release the button, the input stops.



Clear
Clears the input field.



Send
Sends the text in the input field.



Copy
Copies the text in the chat bubble to the clipboard manager.



Stop reading aloud
The next reading will begin from the start of the text.

6.5.2 Functions via gestures

Some functions can be controlled via gestures on the tablet. Pressing and holding means keeping the fingers in place for more than half a second. It is possible to choose which gestures you want to switch off in the settings.

6.5.2.1 Camera view

Pinch

Rotate two fingers

Press with two fingers on the top of the screen

Swipe with two fingers vertically over the top of the screen

Swipe with two fingers vertically over the top of the screen

Press and hold with one finger on the top of the screen

Press and hold with two fingers on the top of the screen

Press and hold with three fingers on the top of the screen

Press and hold with one finger on the bottom of the screen

Double-click with two fingers on the bottom of the screen

Double-click with one finger on the bottom of the screen

Double-click with one finger on the top of the screen

Press with three fingers on the top of the screen

Change magnification

Rotate the image

Natural colours

Artificial colours

Contrast

Start OCR

Start OCR (without switching views)

Take picture for notes tool

Switch full screen

Switch views

Hide menus

Switch camera

Change split mode

Press with three fingers on the bottom of the screen

Open settings

6.5.2.2 OCR view

Pinch

Change magnification

Swipe with one finger

Pan through the image

Press with two fingers on the top of the screen

Natural colours

Swipe with two fingers vertically over the top of the screen

Artificial colours

Swipe with two fingers vertically over the top of the screen

Contrast

Double-click with one finger on the bottom of the screen

Hide menus

Double-click with one finger on the top of the screen

Hide sidebar

Double-click with two fingers on the bottom of the screen

Switch views

Swipe with two fingers vertically over the bottom of the screen

Switch reading mode

Press with three fingers on the bottom of the screen

Open settings

Press and hold with two fingers on the bottom of the screen

Change display mode

6.5.3 Functions via the keyboard

You can connect to a USB or Bluetooth keyboard and control some of the application's functions via the keyboard.

The shortcut commands can be changed in Settings. Below are the standard settings for shortcut commands.

6.5.3.1 General

fn + F1	Natural colours
fn + F2	<p>Positive picture with increased contrast Artificial colours; White/Black, Yellow/Black, Green/Black, Red/Black, Yellow/Blue, White/Blue</p> <p>Press F2 to toggle through the different colours. (Shift + fn + F2 toggles backwards.)</p>
fn + F3	<p>Negative picture with increased contrast Artificial colours; Black/White, Black/Yellow, Black/Green, Black/Red, Blue/Yellow, Blue/White</p> <p>Press F3 to toggle through the different colours. (Shift + fn + F3 toggles backwards.)</p>
Arrow up	Zoom in
Arrow down	Zoom out
Arrow left	Decrease brightness
Arrow right	Increase brightness
Cmd + ,	<p>Open the preferences dialog This key combination is the standard way to open the preferences dialog in a Mac application.</p>
Option + H	Hide menus
V	<p>Switch between camera view and text view If a text has been OCR-processed, this command switches between camera view and text view.</p>

6.5.3.2 Camera view

Option + Arrow Guiding line left/up
left

Option + Arrow Guiding line right/down
right

Option + R Rotates the camera picture clockwise
Each time you press this key combination the picture rotates 90° (90°, 180°, 270°, 0°).

Shift + Option + R Rotates the camera picture counter clockwise
Each time you press this key combination the picture rotates 90° counter clockwise (270°, 180°, 90°, 0°).

R Rotate image clockwise steplessly

Shift + R Rotate image anticlockwise steplessly

Option + I Mirror camera image
By pressing Option + I, you can mirror the camera image. This is a useful feature if you for example would like to use the camera as a magnifying makeup mirror.

fn + F5 Take a snapshot
There is an audible click, and the image is saved. The file name will be today's date and the current time.

fn + Option + F5 Start/stop video recording
Start recording. The application will display an icon indicating that recording is in progress. Stop recording by pressing the button again. The file name will be today's date and the current time.

C Switch camera

Z Change image source

X **Change split mode**

**Shift + left
arrow** **Move split left/up**

**Shift + right
arrow** **Move split right/down**

6.5.3.3 OCR view

fn + F4 **OCR process**
This command takes a picture for OCR processing. The program then switches to text view and the OCR processed text is read aloud.

Minus **Decrease font size**

Plus **Increase font size**

1 **Start/Pause reading**
If no reading is currently in progress, reading starts, otherwise reading is paused.

2 **Stop reading**
This command stops the reading. The next reading will begin from the start of the text.

3 **Read previous**
With this command, the user can go backwards through the text. If the reading mode is sentence, you move backwards through the text one sentence at a time. If the reading mode is word, you move backwards through the text word by word. If the reading mode is set to character, one character is read for each keystroke.

4 **Read next**
With this command, the user can move forward in the text. If the reading mode is sentence, you move forward through the text one sentence at a time. If the reading mode is word, you move forward through the text word by word. If the reading mode is set as character, one character is read for each keystroke.

5 **Switch reading mode**
This command selects the reading mode that is to be employed when the "Read previous" or "Read next" command is entered. The modes are, character, word, sentence, view and block. Which modes can be selected depends on the display mode.

B **Display mode**
Switches to display mode for OCR-processed text. The available display modes are: "page view", "row view", "word view", "image view", "image and word" and "image and row".

6.5.3.4 Notepad view

fn + F7 **Take a picture and open in Notepad**

Option + N **New Page**

Option + O **Open image**
From the dialog box, select the file you wish to open. It is possible to open PDF files and image files.

Option + S **Save image**
A dialog box where you can choose the file format (PDF and JPEG) appears. You can then choose where you want to save the file.

Cmd + Z **Undo**

Shift + Cmd + Z **Redo**

Option + R Rotate clockwise

Shift + Option + R Rotate anti-clockwise

Option + P Select pen tool

Option + L Select the highlighter tool

Option + T Select text tool

Option + E Select the eraser tool

Option + F Select the pan tool

6.5.4 Information and settings window

The Information and settings window consists of a number of different tabs that contain application information and alternative settings.

6.5.4.1 About the application

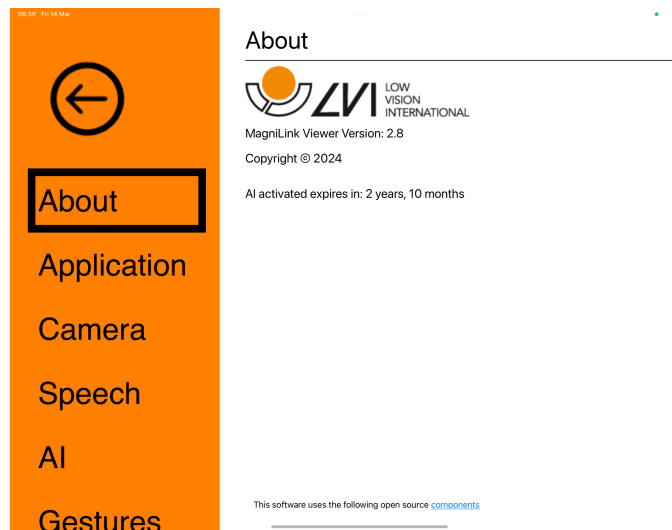

Under this tab you will find information about the camera and the software version.

If you want to activate the AI feature, you can do so by entering a license code and clicking "Activate".

6.5.4.2 Application Settings

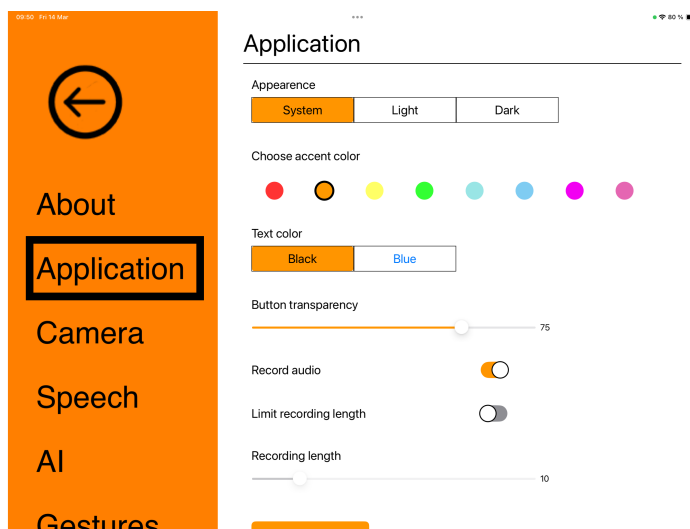

Appearance

Choose between light, dark or system appearance

Accent color

Choose accent color

Text color

Choose textcolor

Button transparency

Set the transparency for the camera buttons

Record audio

Choose whether to record video with audio

Limit recording length

Activate this function to limit the recording length.

Length in minutes

If you have chosen to limit the recording length you can set the limit herein minutes, from 1 to 60 minutes.

6.5.4.3 Camera settings

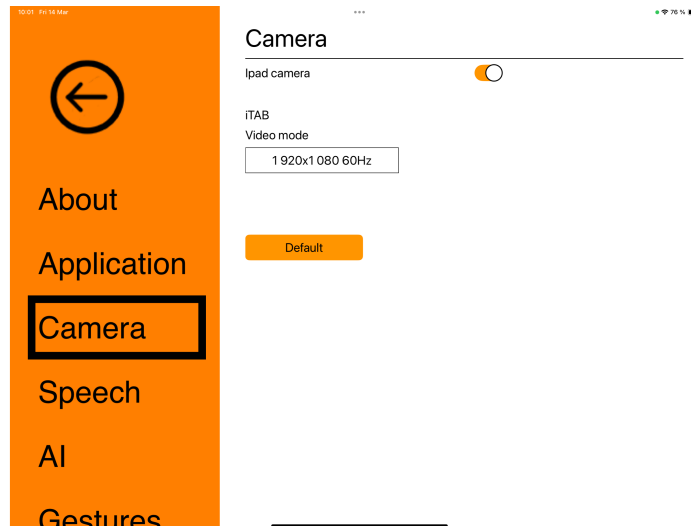

iPad camera

When this is deselected, it is not possible use the built-in cameras.

Video mode

Select between the different video modes of the camera

6.5.4.4 Speech Settings

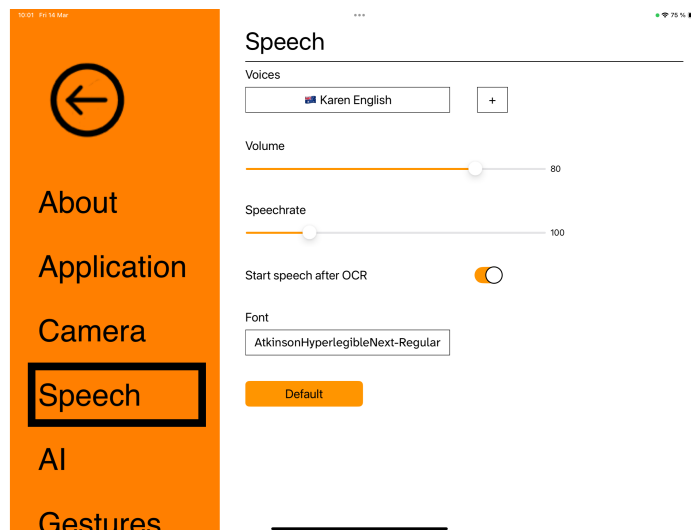

Voices

If several voices are available, the user can choose between them. You can get other voices by downloading languages in the iPad's settings. The OCR engine only supports languages that use the Latin alphabet.

Volume

Setting for the sound level of the voice.

Speaking speed

Setting for the speaking speed.

Start speech after OCR

If this box is checked, text will automatically be read aloud after an image has been OCR processed.

Font

Here the user can set the font for displaying the OCR processed text. The choice of font has no bearing on the OCR result.

6.5.4.5 AI Settings

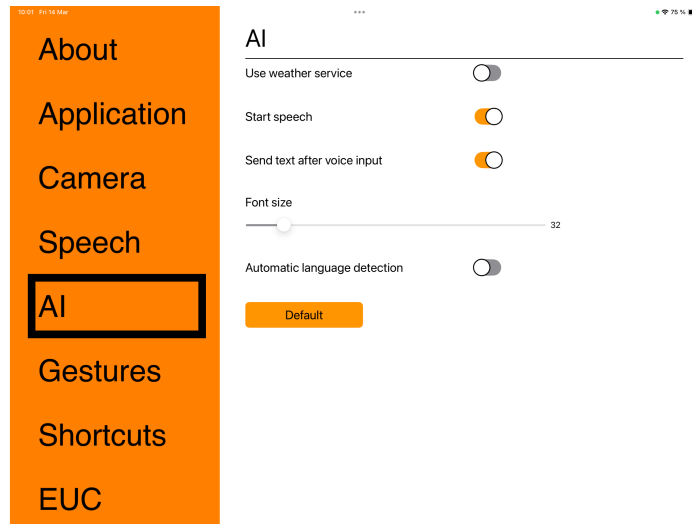

Start reading

When this is checked, the reading starts immediately when you receive a message.

Send text after voice input

When this is checked, the text is automatically sent after voice input.

Font size

Here you can set the font size.

Automatic language detection

When this feature is enabled, the application tries to identify the language and change the voice accordingly.

6.5.4.6 Gestures

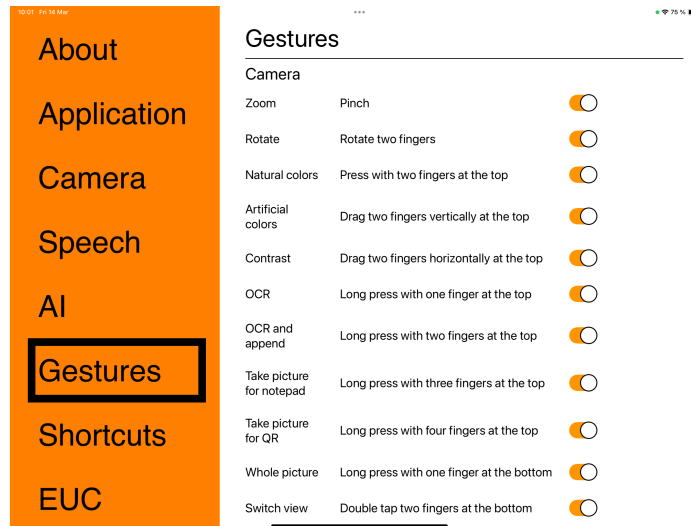

Here you can choose which gestures will be used. To turn off a gesture, you can untick the relevant box.

6.5.4.7 Short cut commands

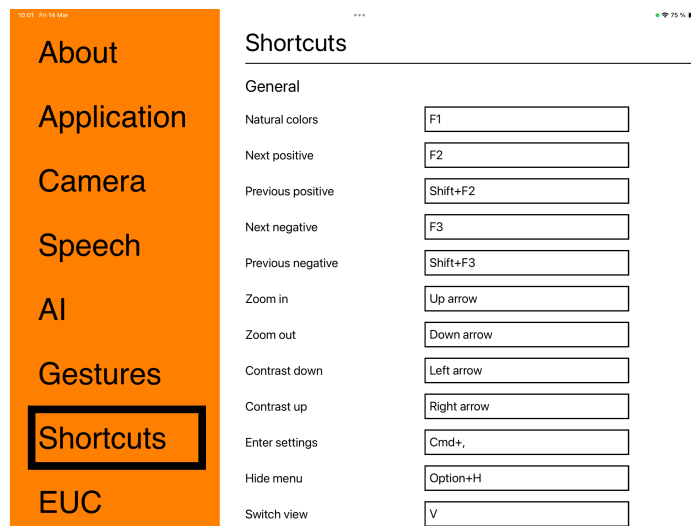

Here the short cut commands used for the application can be changed. To change a short cut command, tab to the command that is to be changed and enter the new keyboard combination. If a combination already being used for another command is entered, the other command will be erased. A new keyboard combination will need to be entered for the other command.

6.5.4.8 EUC

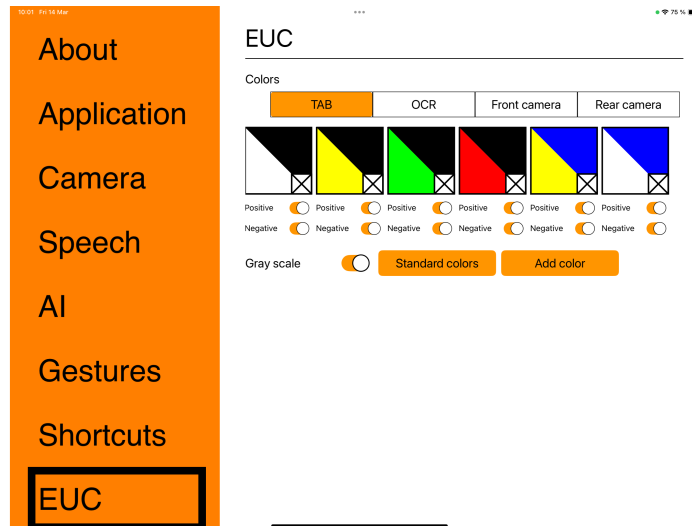

The camera can be configured under this tab.

Colours

It is possible to remove and change the camera's artificial colours.

- To remove a colour combination, press X.
- To add a colour combination, press Add.
- To change a colour combination, press one of the triangular fields and a colour dialog box will appear. Select colours and press OK.
- To remove either the positive or the negative component. Uncheck the "Positive" or "Negative" checkboxes.
- To restore the colours, press "Default colours".

Grey scale

Choose if you wish to have grey scale or not.

7 Ergonomics

It is important that the workplace around your system is comfortable, and that you sit correctly. This is so that you can use it for as long as possible without putting undue strain and stress on your neck and back.

You should bear the following in mind.

- Your chair should be positioned close to the table on which the equipment is located, and you should not sit in the chair for too long. We recommend a good office chair with adjustable height.
- The seat of the chair should be at a height that does not cause your legs to become numb; legs should be at an angle of 90 degrees and you should rest your feet on the floor.
- The table should be at a height at which you can rest your lower arm horizontally on it. It is important that the table is neither too high nor too low for you. The ideal solution is if the screen is slightly below eye level and in as straight a line in front of you as possible.
- Shield out daylight. Lights in the ceiling, table lamps and light from windows can cause reflections on the monitor. For this reason, avoid placing lights where they shine directly at the screen or at yourself.
- If you use the device for long periods of time, there is a risk of repeated movements causing you pain in your neck, shoulders and back. Your eyes can also get tired from looking at a screen for too long.

8 Technical information

Stand

Dimensions collapsed	365 x 300 x 30 mm (W x D x H)
Dimensions, opened up	230 x 310 x 350 mm (W x D x H)
Weight	3.0 Kg
Power adapter, AC input	100-240 V, 50-60 Hz
Power adapter, DC output	5 V 3 A; 9 V 3 A; 12 V 3 A; 15 V 3 A; 20 V 3.25 A (USB-C PD)
Power adapter, power	65 W (Max)

Distance camera

Magnifying area	0.9 - 50x (height 33 cm, Surface Pro 13")
Weight	700 g
Frame rate	60 Hz
Length of camera and arm	620 mm

Service Life and Safe Use

In compliance with the Medical Device Regulation (EU) 2017/745, the manufacturer specifies the period during which the device is expected to maintain safe and effective performance under normal conditions of use. For this device, the recommended service life is 3 years from the date of purchase.

Note:

The indicated service life does not represent the full technical lifetime of the product. It reflects the period during which the device's performance and safety have been verified by the manufacturer. After this period, the device may still function, but technological developments or wear related factors may justify evaluation for potential replacement.

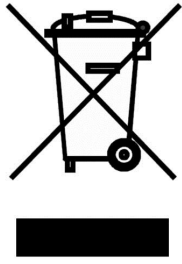

Disposal of old electrical and electronic equipment (applies for EU countries and all other European countries that have specific collection systems)

If the product or its packaging has this symbol on it, it is not to be handled as regular domestic waste. It should instead be deposited at a suitable collection centre for the recycling of electrical and electronic equipment. By ensuring that this product is properly taken care of, you are helping to prevent the negative impact on health and the environment that might otherwise result from inappropriate disposal of this product. Recycling helps in the management of our natural resources. For more detailed information regarding the recycling of this product, you can contact your municipality, your waste management company or the store where you purchased the product.

9 Declaration of Conformity

DECLARATION OF CONFORMITY

Manufacturers name: *LVI Low Vision International AB*

Manufacturers Address: *Verkstadsgratan 5
S-352 46 Växjö
Sweden*

Web: *http://www.lviglobal.se*

SRN (Single Registration Number): *SE-MF-000004178*

Basic UDI-DI (GMN): *7330724ML-iTABTJ*

Brand name or trademark: *MagniLink*

Product code: ***ML-iTAB***

Classification: *Class 1*

Type of equipment: *Reading Aid*

Conformity assessment route: *LVI Low Vision International AB uses the procedures for the CE-labeling of their products according to Article 52(7) of Regulation MDR 2017/745.*

This declaration of conformity is issued under the sole responsibility of LVI Low Vision International AB. We hereby declare that the medical device(s) specified above meet the provision of the Regulation (EU) MDR 2017/745 for medical devices and Regulation (EU) 2023/1542 concerning batteries, where it is applicable. This declaration is supported by the Quality System approval to ISO 9001 issued by Intertek. All supporting documentation is retained at the premises of the manufacturer.

Manufacturer Manufacturer's authorized representative

Date
20-11-2023

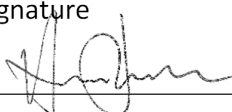
Signature

Position
Managing Director

Clarification
Henrik Blomdahl

Alphabetical index

About LVI	1
About the application	29
Activate driver	11
AI Settings	32
AI view	21
Application Settings	30
Camera settings	31
Camera view	11, 23, 26
Cleaning	4
Connection	8
Declaration of Conformity	38
Distance camera	8
Ergonomics	35
EUC	34
Functions via gestures	22
Functions via menus	11
Functions via the keyboard	25
General	25
Gestures	33
Hardware	7
Information	4
Information and settings window	29
Installation of software	10
Introduction to MagniLink iTAB	2
MagniLink Viewer	10
Minimum system requirements	10
Notepad view	19, 28
OCR view	16, 24, 27
Packaging	6
Recommended system requirements	10
Reuse, installation and maintenance	4
Safety information	4
Short cut commands	33
Speech Settings	31
Stand	7
Tablet computer	8
Technical information	36
Unpacking	6
Using the software	11